

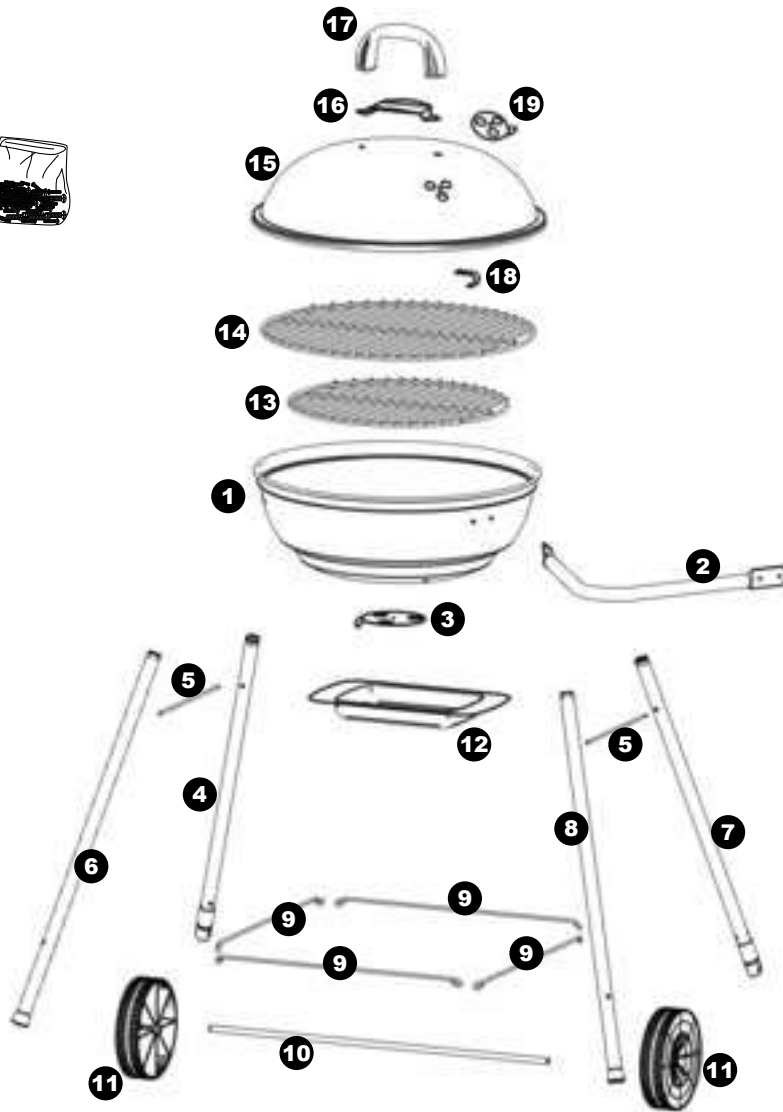







# TOM 340435i (NF)





	6 x 16	6
	4 x 35	4
	4 x 12	6
	Ø25	4

	Ø6	2
	Ø4	10
	Ø8	2
	Ø4	10















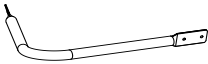
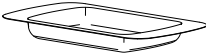



APPAREILS MÉNAGERS  
UTILISANT DES COMBUSTIBLES  
LIQUIDES OU SOLIDES

[www.marque-nf.com](http://www.marque-nf.com)

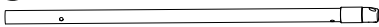
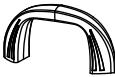

DOMESTIC APPLIANCES  
USING LIQUID OR SOLID FUELS

[www.marque-nf.com](http://www.marque-nf.com)

<b>1</b>		x 1	<b>11</b>		x 2
<b>2</b>		x 1	<b>12</b>	 cendrier	x 1
<b>3</b>		x 1	<b>13</b>		x 1
<b>4</b>		x 1	<b>14</b>		x 1
<b>5</b>		x 2	<b>15</b>		x 1
<b>6</b>		x 1	<b>16</b>		x 1
<b>7</b>		x 1	<b>17</b>		x 1
<b>8</b>		x 1	<b>18</b>		x 1
<b>9</b>		x 4	<b>19</b>		x 1
<b>10</b>		x 1	<b>20</b>		x 1

**1**

Ø4x12 Ø4 Ø4

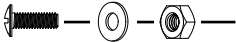
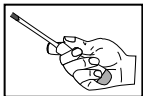
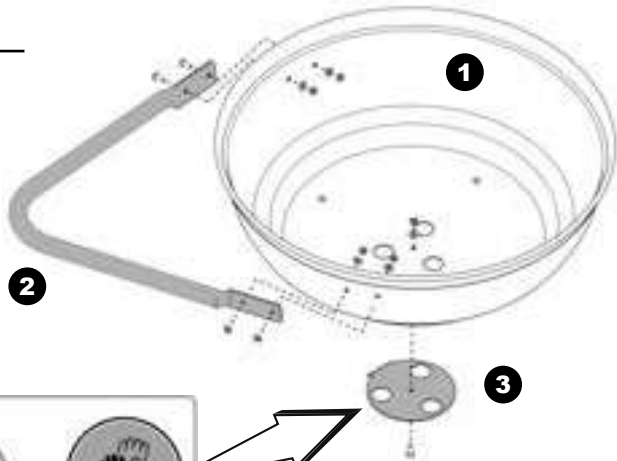

  
x 5 x 5 x 5
**2**

Ø6 x 16

Ø25

x 4

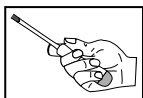
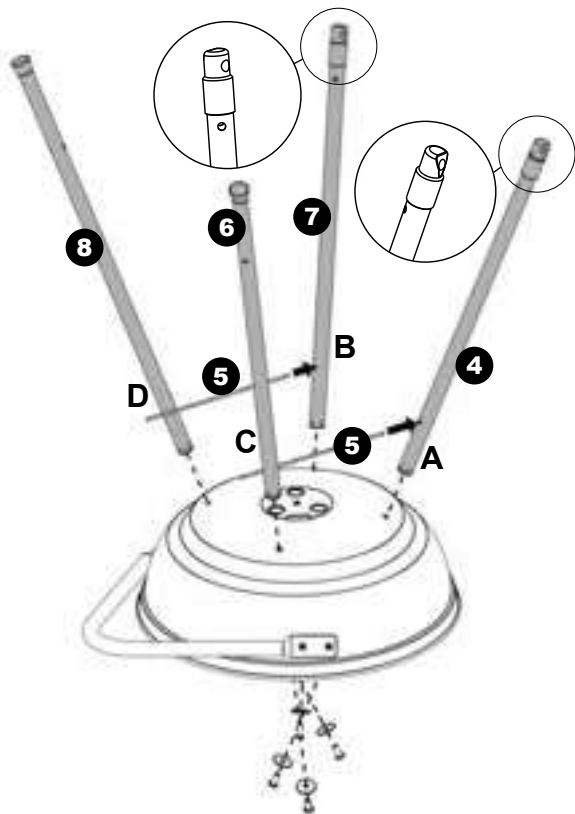
x 4



**3**

Ø4 x 35 Ø4 Ø4

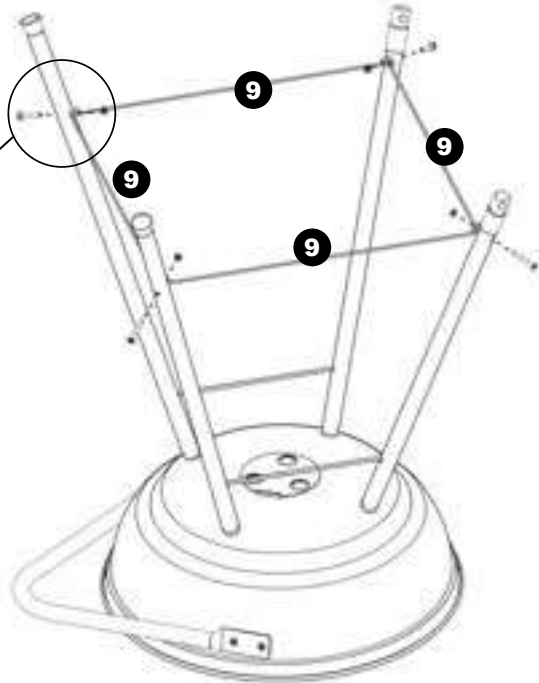
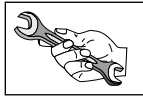
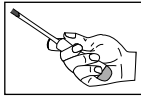
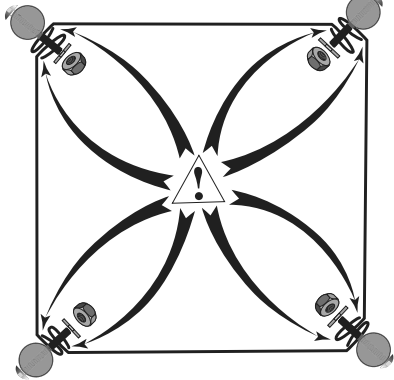
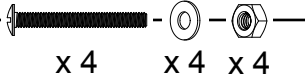
**4**

Ø8 Nylstop

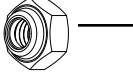

x 2

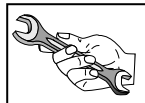
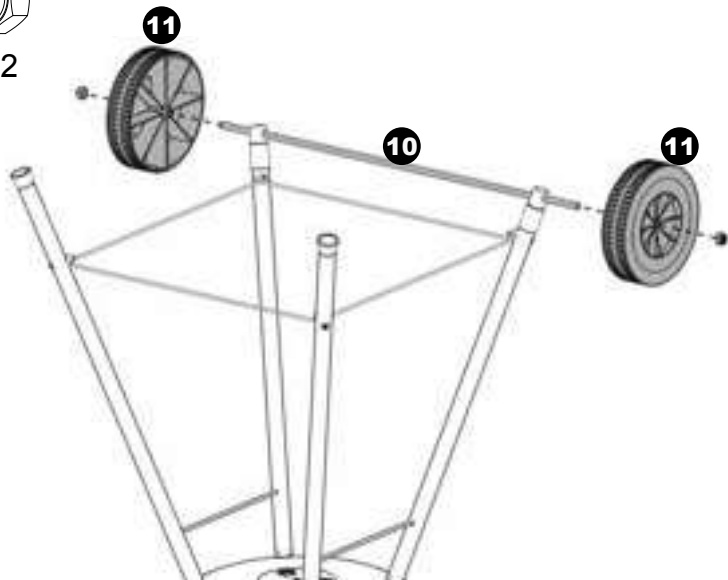

**5**

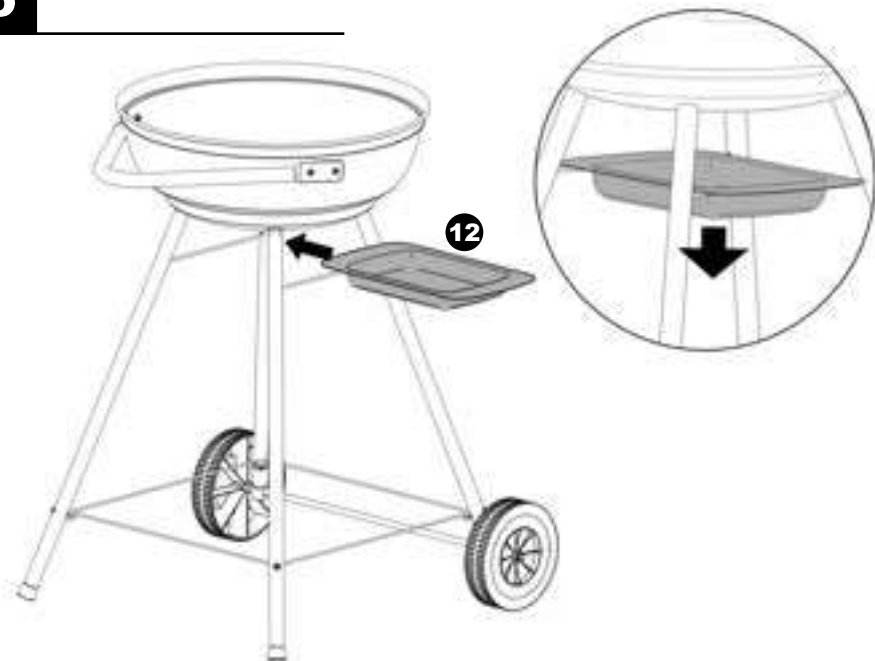

**6**

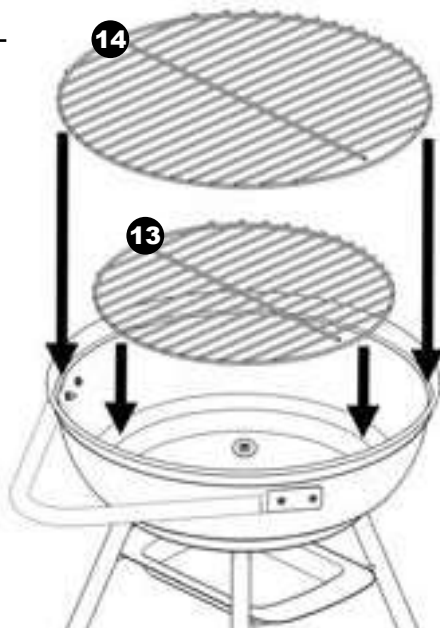

**7**

Ø4x12    Ø4    Ø4    Ø6 x 16    Ø6  
x 1    x 1    x 1    x 2    x 2

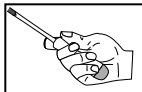
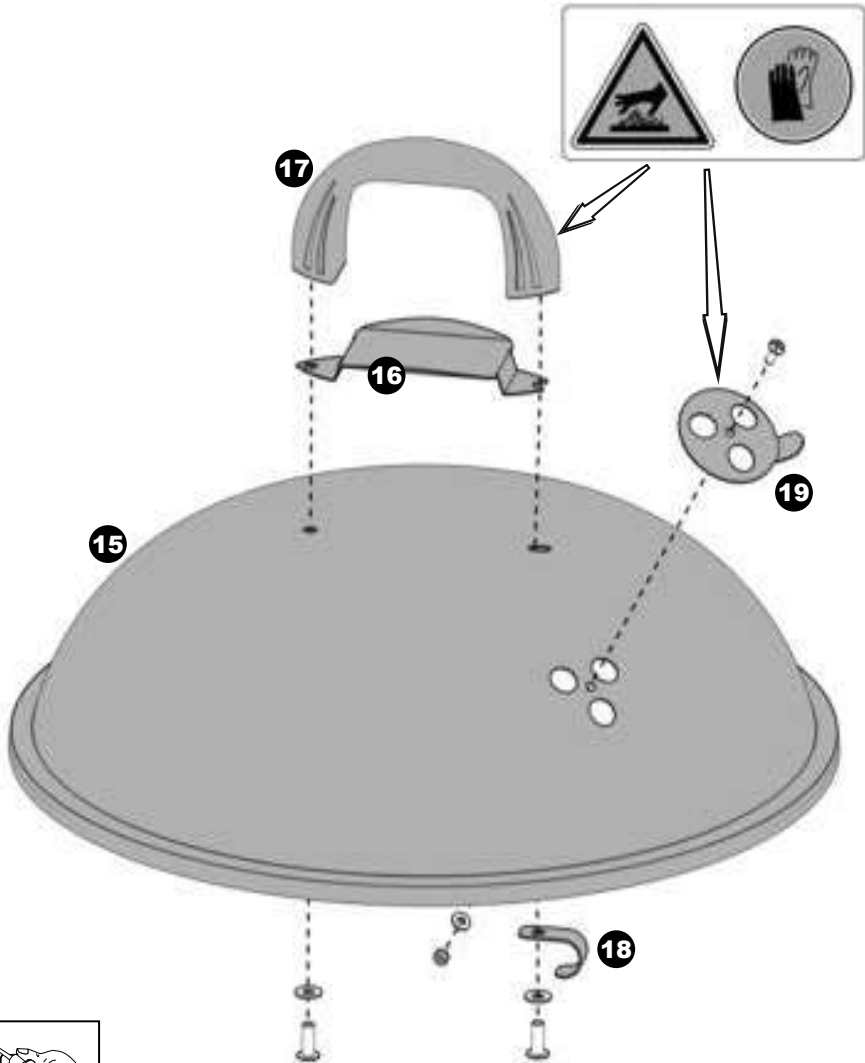

8

