

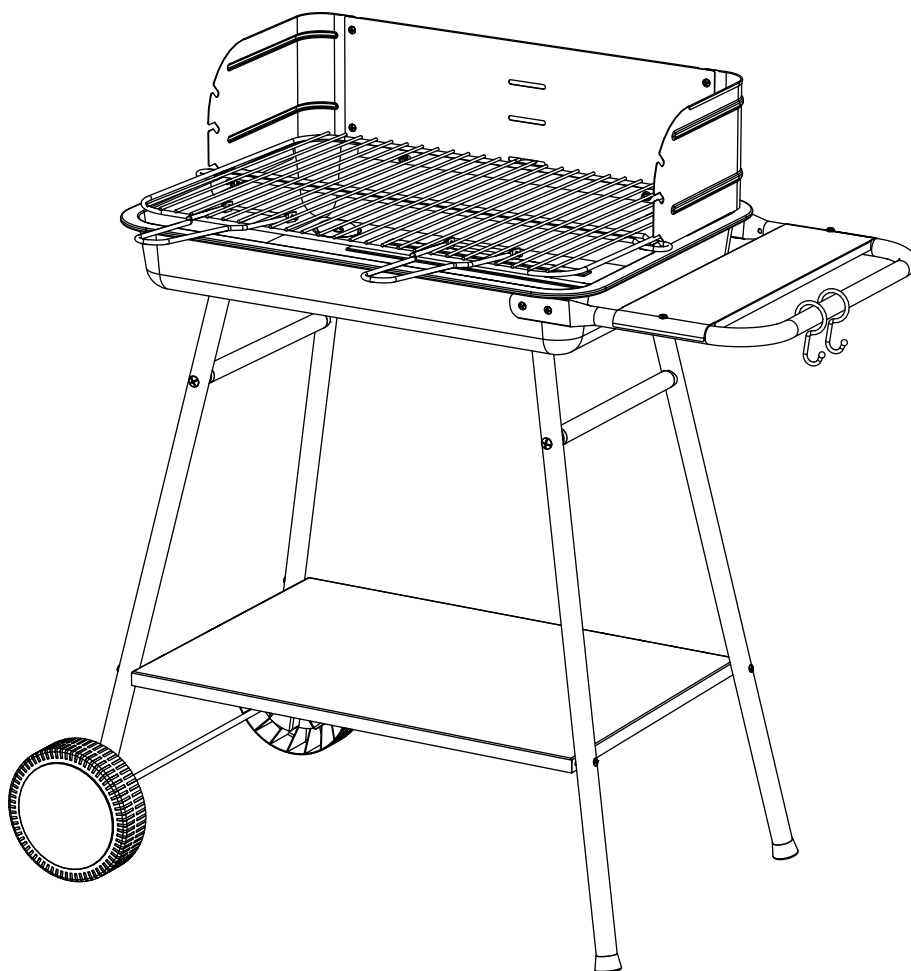

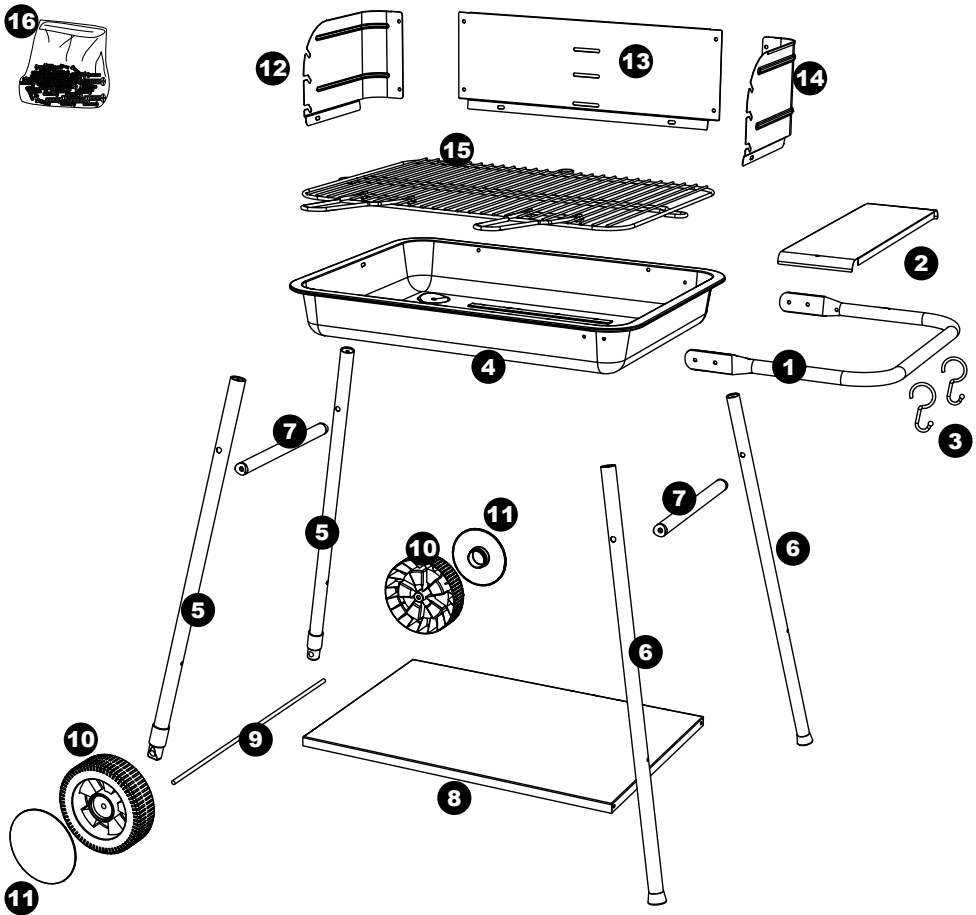









# TOM 325436i 005 (NF)





	3,5 x 9,5	2
	6 x 40	4
	6 x 12	4
	4 x 30	4
	4 x 12	8
	4 x 8	4









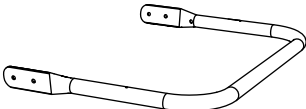

	Ø45	4
	Ø6	4
	Ø4	16
	Ø8	2
	Ø4	16

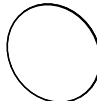
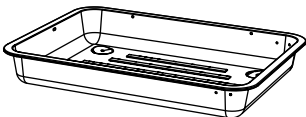

APPAREILS MÉNAGERS  
UTILISANT DES COMBUSTIBLES  
LIQUIDES OU SOLIDES  
[www.marque-nf.com](http://www.marque-nf.com)

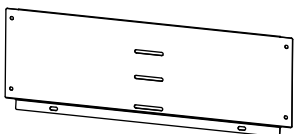

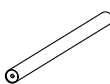
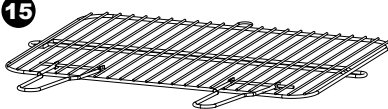
DOMESTIC APPLIANCES  
USING LIQUID OR SOLID FUELS  
[www.marque-nf.com](http://www.marque-nf.com)

<b>1</b> 	x 1	<b>9</b> 	x 1
<b>2</b> 	x 1	<b>10</b> 	x 2
<b>3</b> 	x 2	<b>11</b> 	x 2
<b>4</b> 	x 1	<b>12</b> 	x 1
<b>5</b> 	x 2	<b>13</b> 	x 1
<b>6</b> 	x 2	<b>14</b> 	x 1
<b>7</b> 	x 2	<b>15</b> 	x 1
<b>8</b> 	x 1	<b>16</b> 	x 1

**1** $\text{Ø}3,5 \times 9,5$ 

x 2

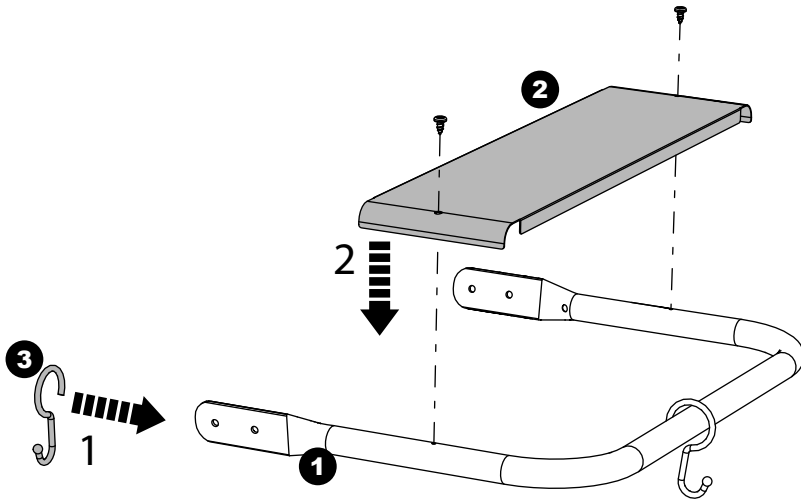
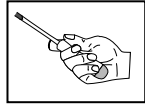
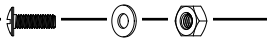
**2** $\text{Ø}4 \times 12$   $\text{Ø}4$   $\text{Ø}4$ 

x 4    x 4    x 4

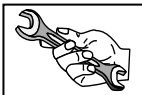
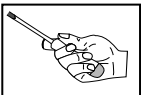
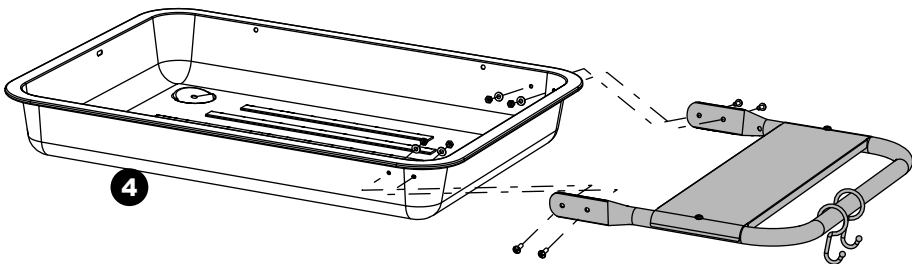

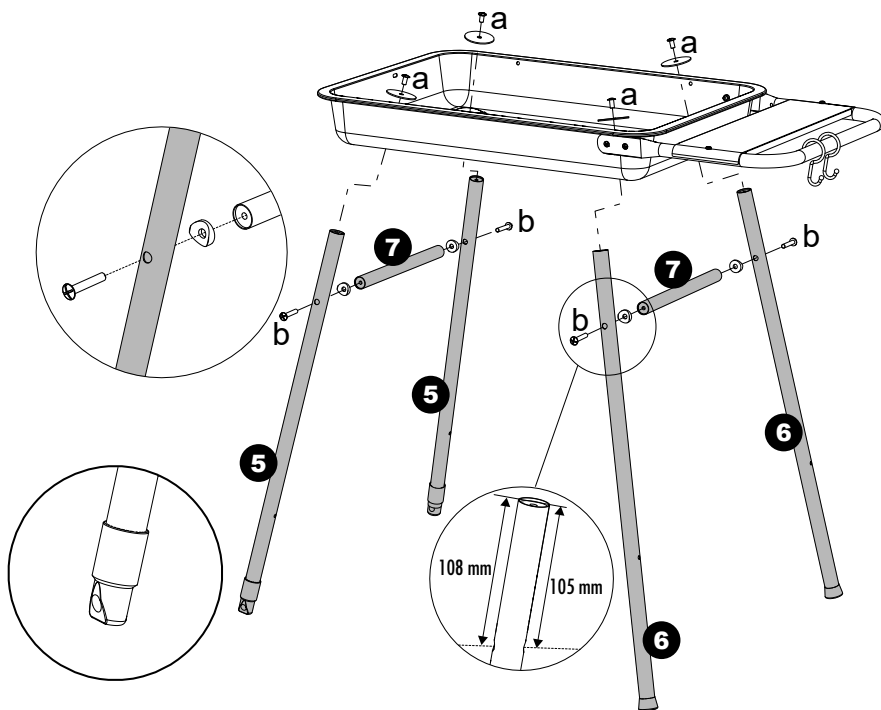
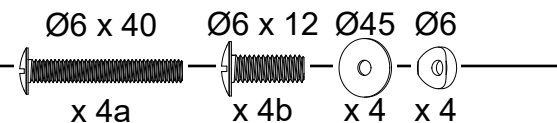
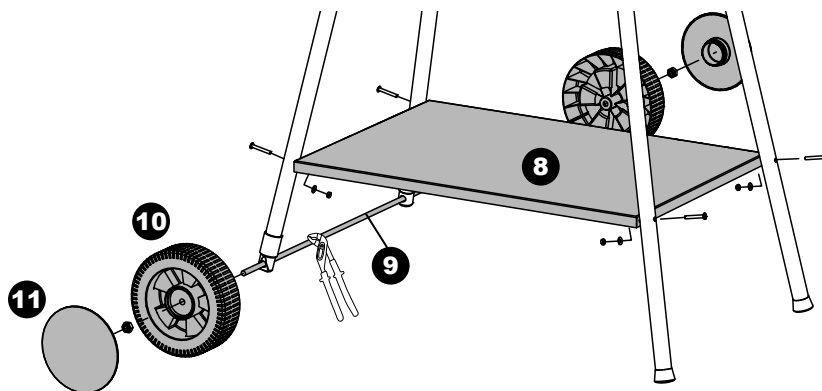
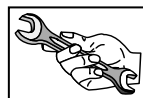
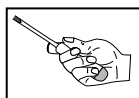
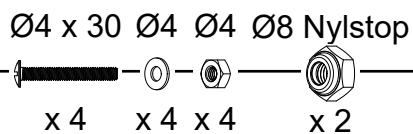
**3****4**

**5**

Ø4x8

Ø4x12

Ø4

Ø4

x 4a

x 4b

x 8

x 8

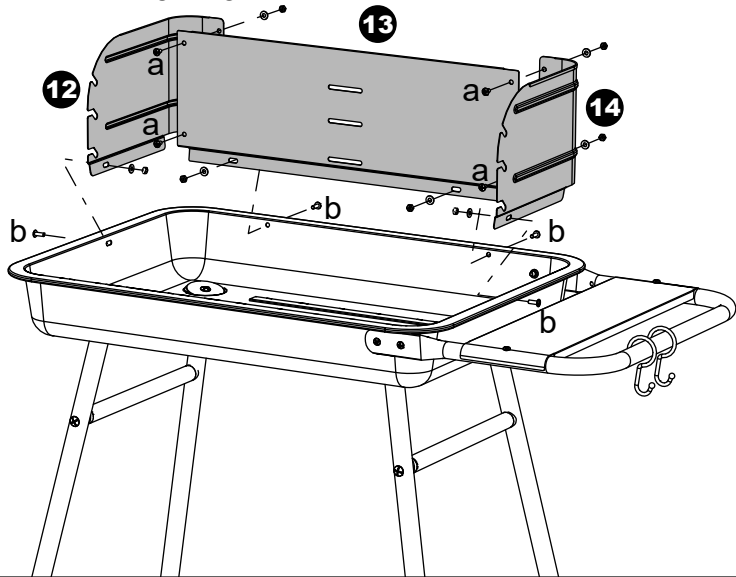
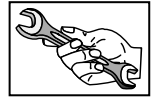
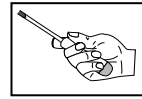
**6**